



Recent advances in the BRAMS network

Hervé Lamy & BRAMS team

Belgian Institute for Space Aeronomy (BISA)

METRO annual meeting
Brussels-27/10/2015

The BRAMS network

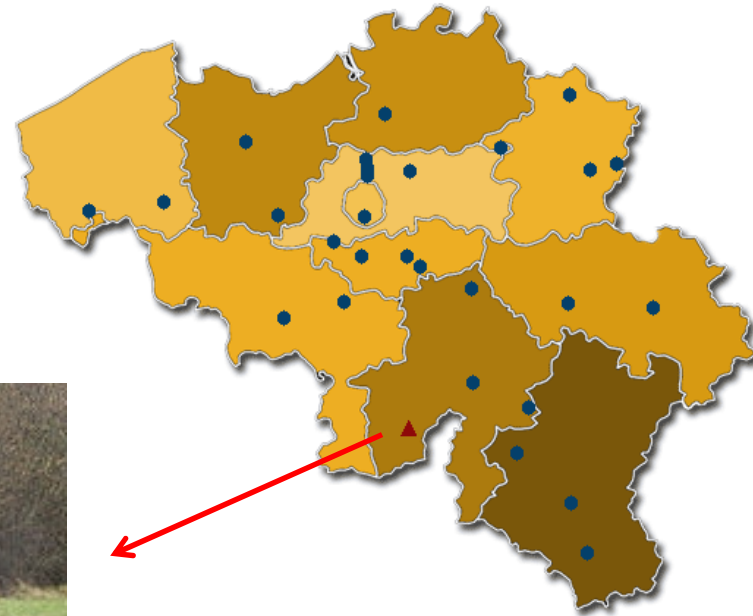
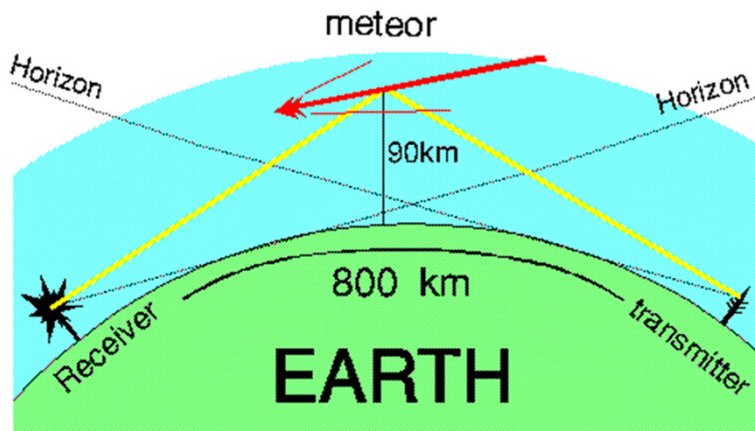
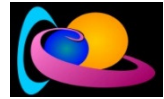

- ✓ 49.97 MHz
- ✓ 150 W
- ✓ pure sine wave



Typical BRAMS receiving station

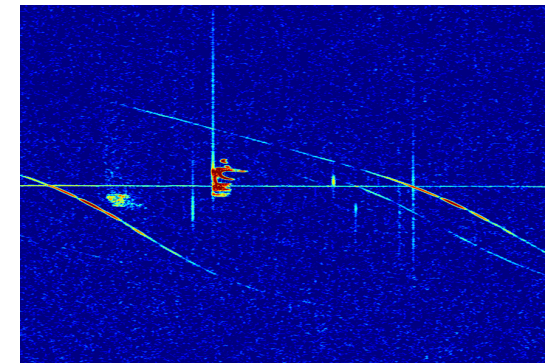
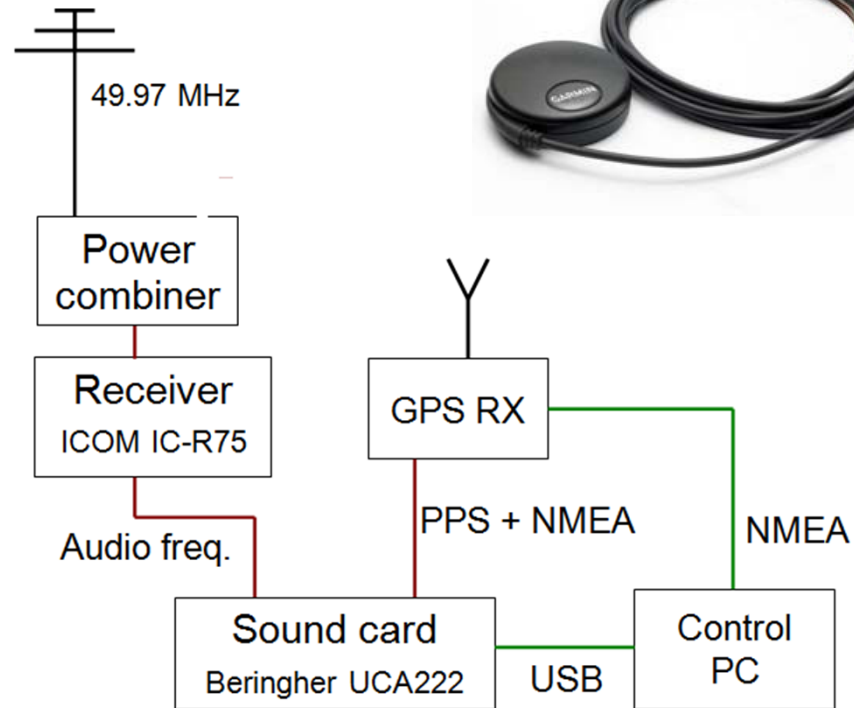

BRAMS calibrator

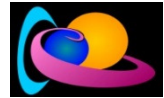

Goal : Monitor gain and frequency offset/drift at every station

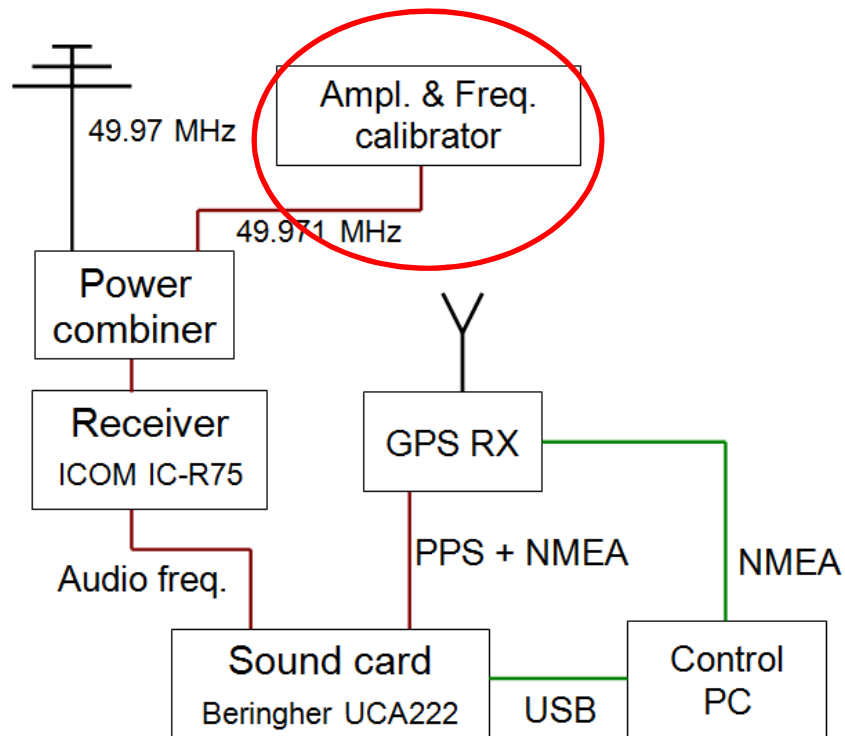

- Power level : -130 dBm (10^{-16} W)
- Frequency 49.97050 Mhz => 1.5 kHz in audio band

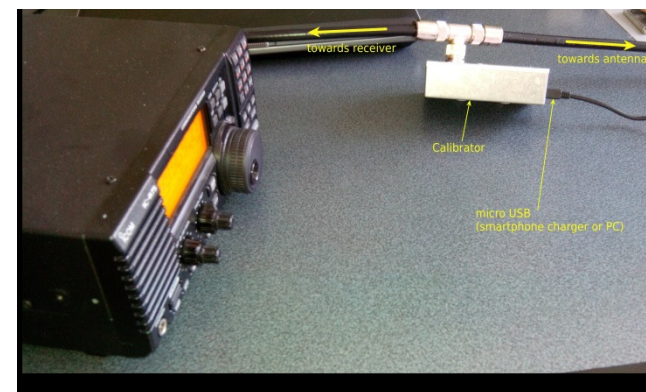

BRAMS calibrator

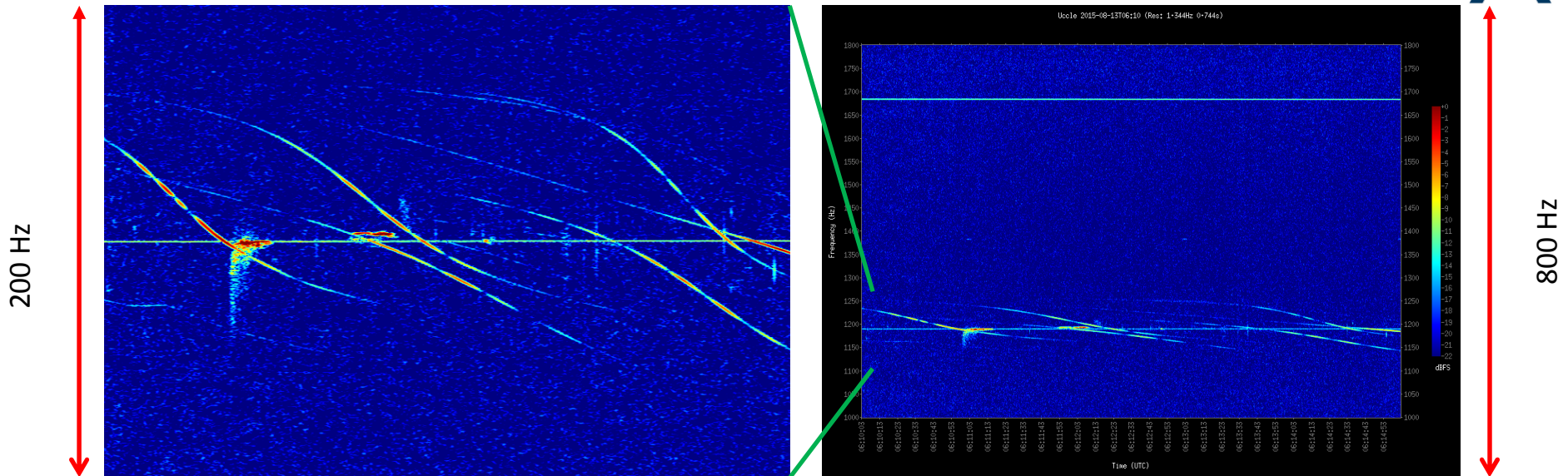
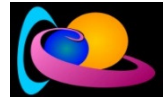

The frequency of the BRAMS calibrator is very stable (\sim few Hz) which is much better than the one of the LO of the receiver (that can drift up to 200 Hz depending on temperature). Frequency drifts of LO will affect beacon and calibrator frequencies in the same way such that the frequency range between them \sim 500 Hz.

Importance of BRAMS calibrator

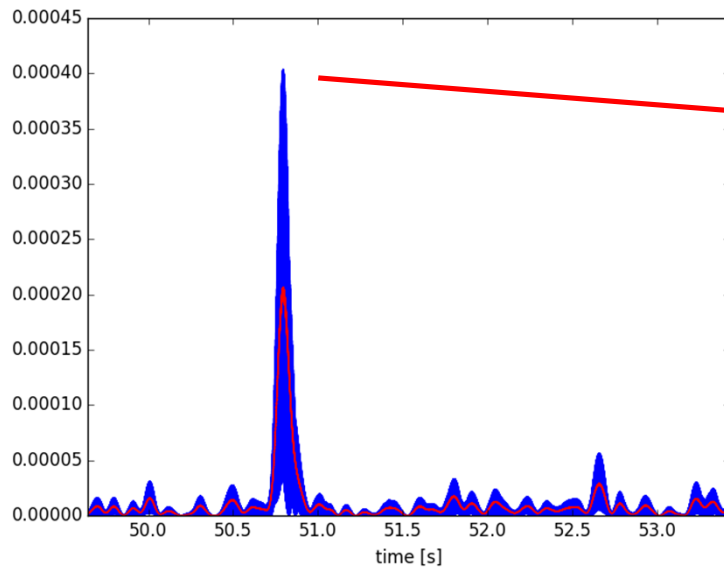
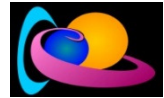

$$\frac{P_T G_T G_R \lambda^3 r_e^2 \alpha^2 \sin^2 \gamma}{16\pi^2 R_T R_R (R_T + R_R) (1 - \sin^2 \phi \cos^2 \beta)}$$

4 type of parameters :

- Geometry parameters (R_T, R_R, ϕ, β)
- Technical parameters (P_T, G_T, G_R, λ)
- Polarisation of the wave γ
- Ionisation at the reflection point α

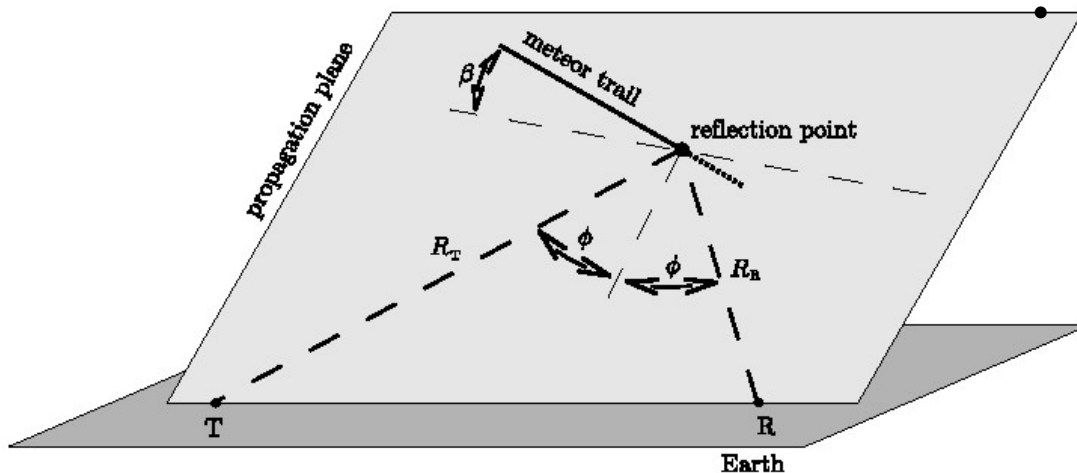

Importance of BRAMS calibrator

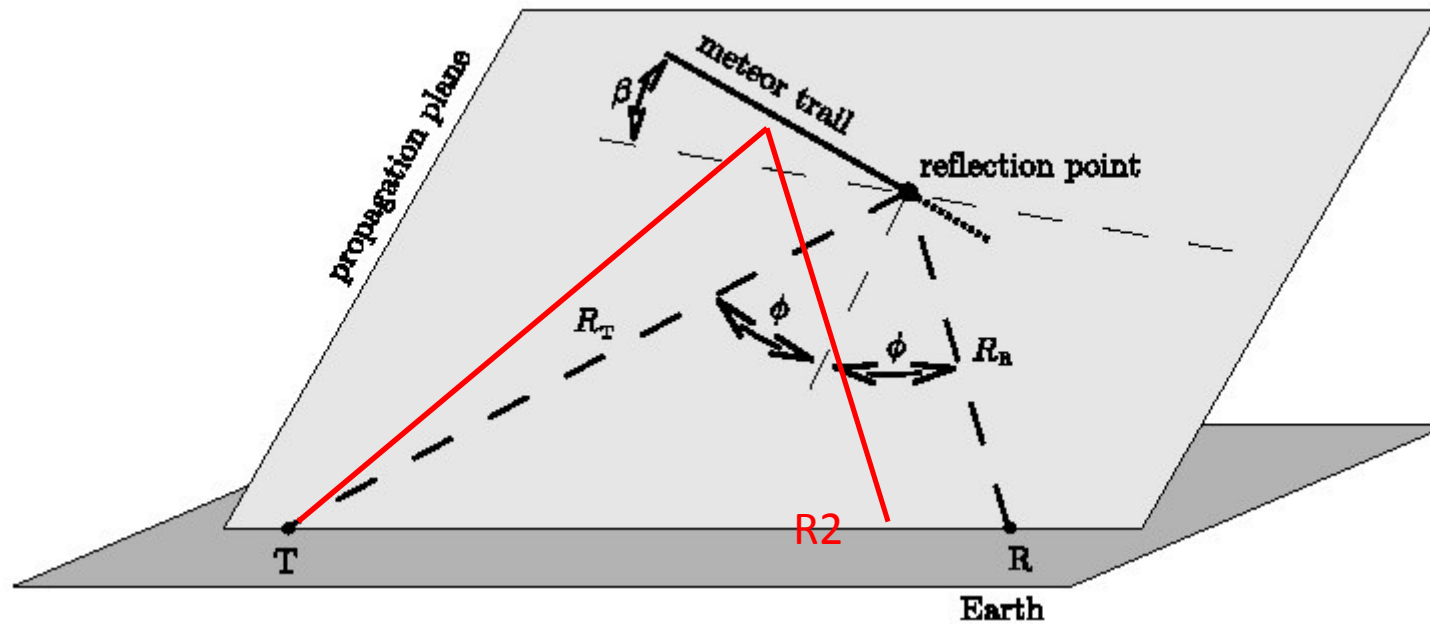

Ionisation in several points → estimate of mass of meteoroid using ablation model (complex inverse problem, collaboration with VKI)

Interferometric station in Humain

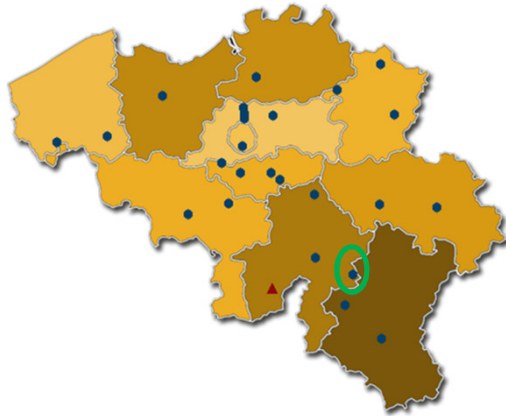

Jones et al (1998)

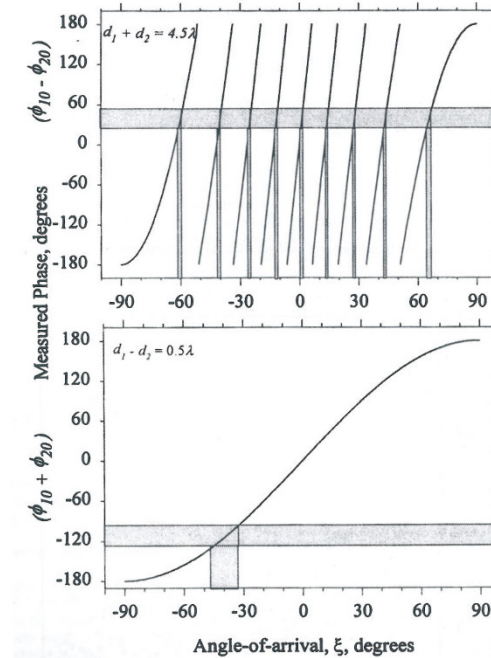
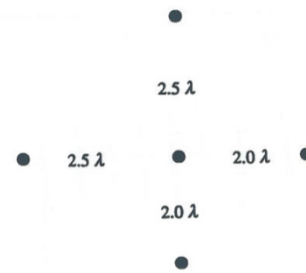
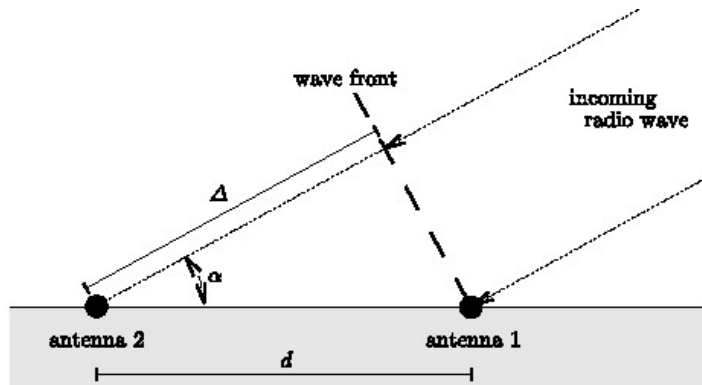

Next?

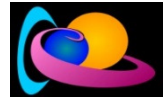

Using the BRAMS calibrator
as Tx (payload) to test the
direction retrieval algorithm

Automatic detection of meteor echoes



- 30 receiving stations
- 288 files of 5 minutes per day and per station
- 1500-2000 meteor echoes per day

Method using the time signal

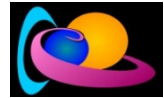

See Roelandts (2014)

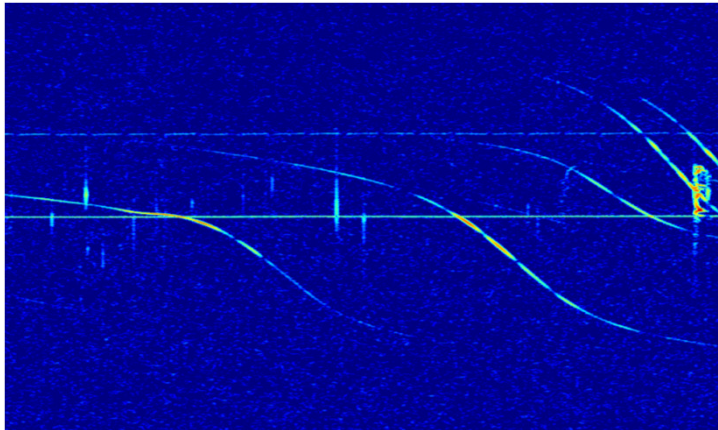

$$I[n] \equiv \frac{E_S[n]}{E_L[n]}$$

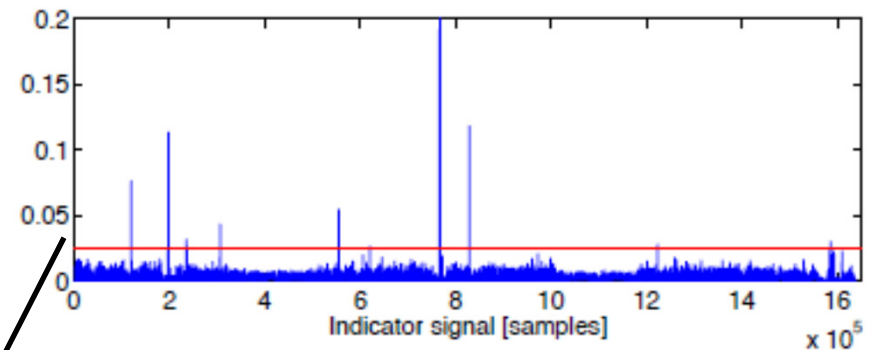
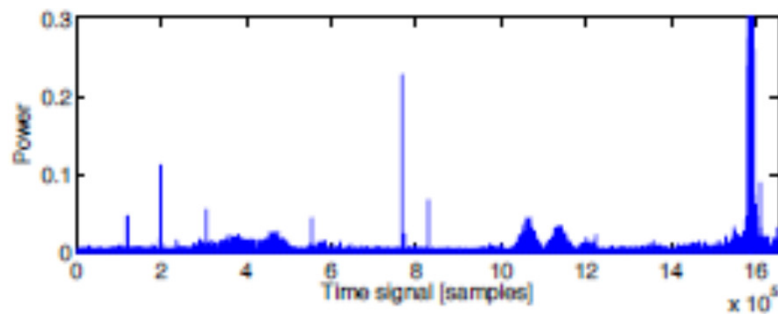

Threshold (1 of 3 parameters)

Test of the method : data

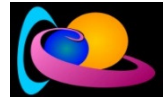

- 1h of data (12 spectrograms) for 2 stations :
 - one “simple” at night (no planes)
 - one complex with “crazy” plane echoes
- Careful manual counts by several users

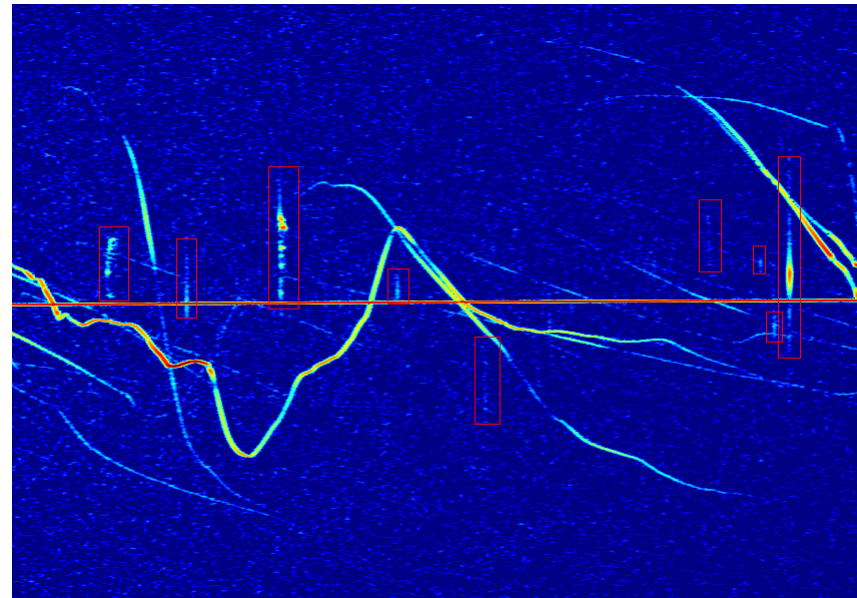
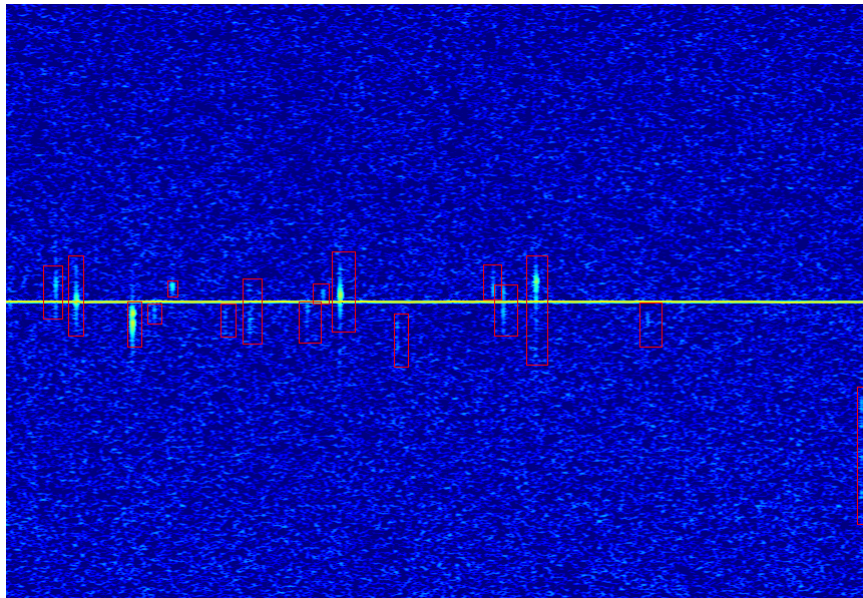

Test of the method : results

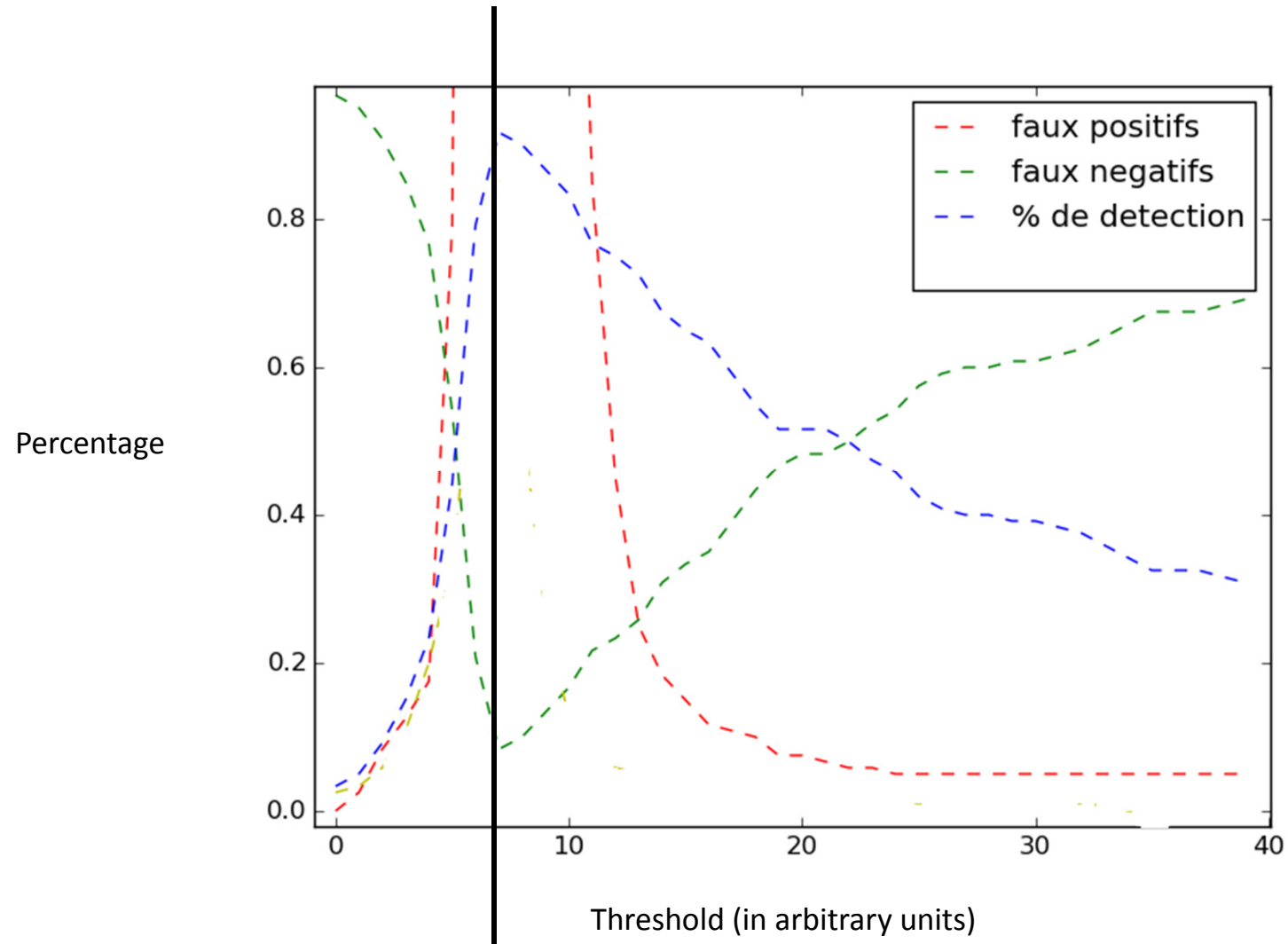
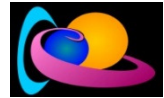

Automatic detection : new idea

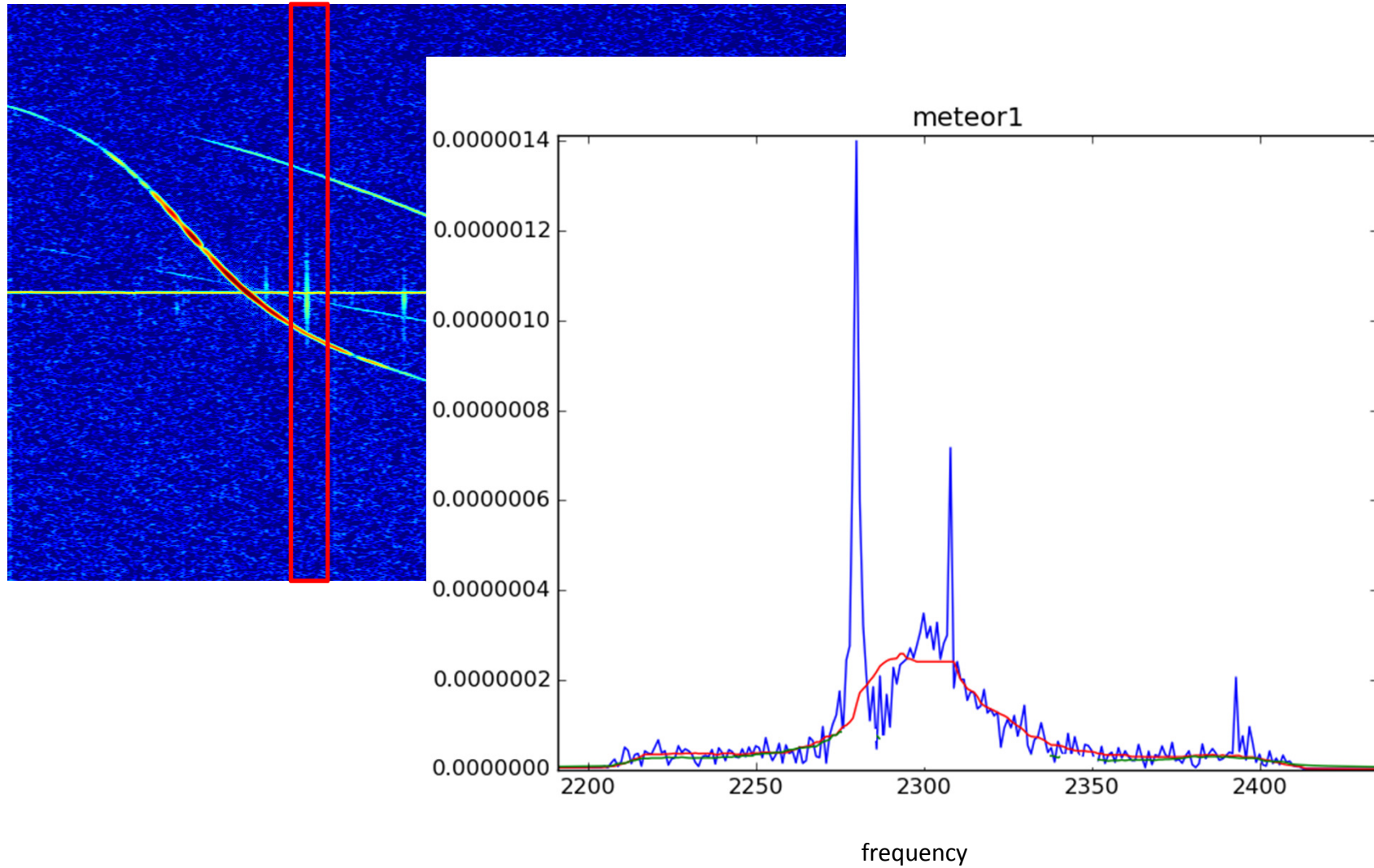
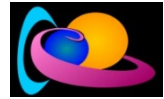

Example of results

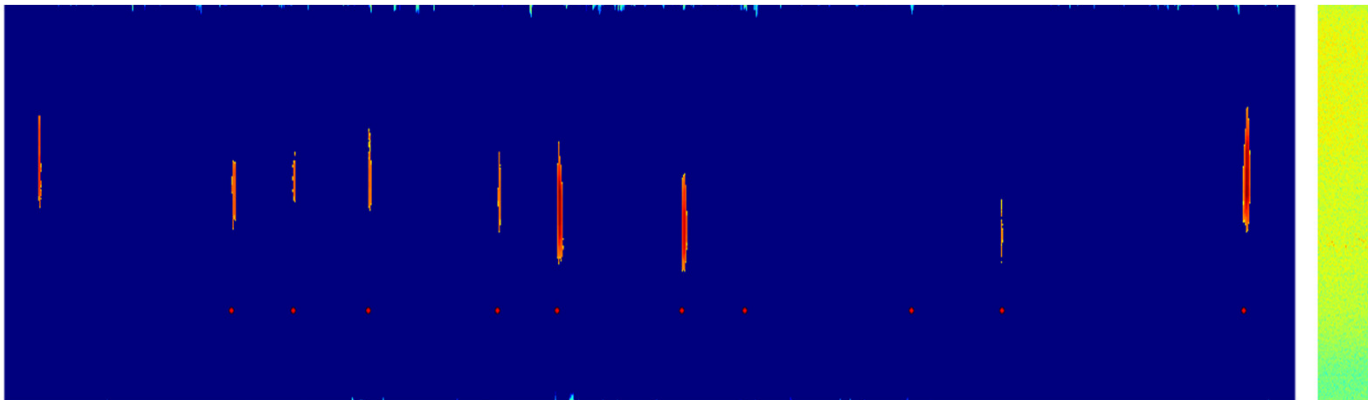
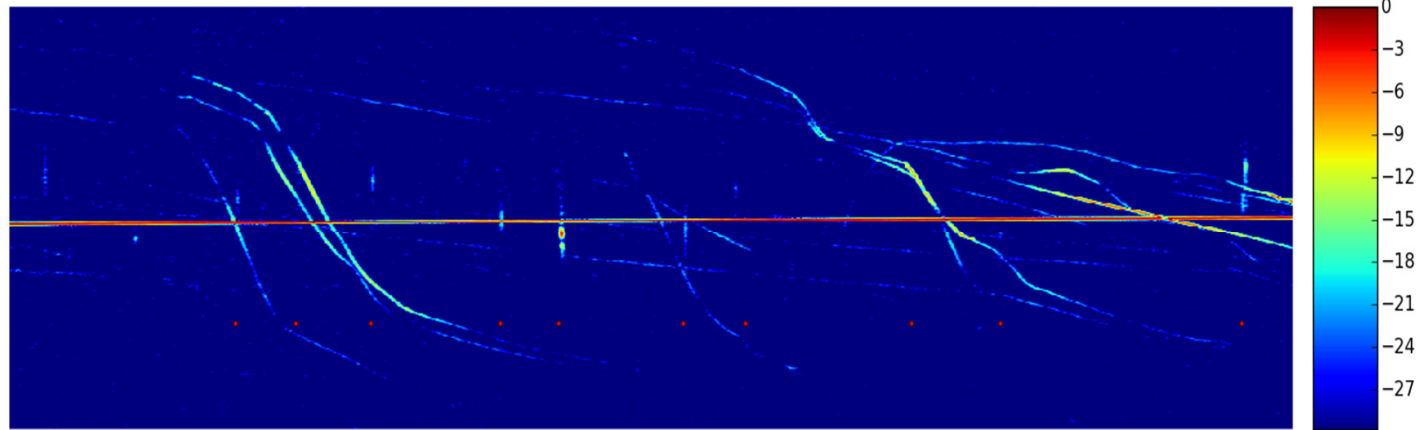

Other activities



1. BRAMS Zoo
2. Measurements of radiation pattern of BRAMS antennas
3. Meteoroids trajectories retrieval : project funded by Belgian Scientific Policy called METRO (started 2 months ago, duration : 4 years)



Thank you

brams.aeronomy.be